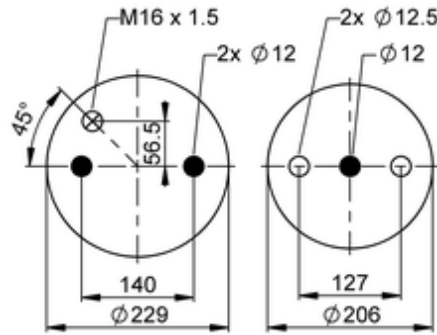
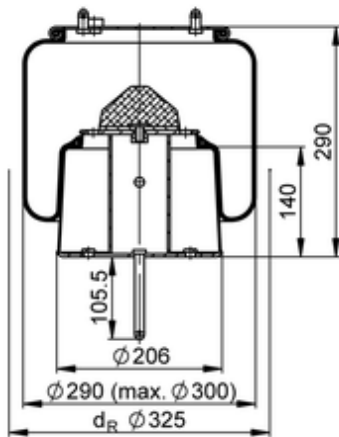

**6710 N P04**
**53875**

- bolt or stud
- hole
- combination stud
- air inlet
- stud and nut

Article status	Normal
GTIN/EAN	4054396100215
Bellow number	6710 N
kg	8,3 kg
	K031
	M16x1.5: max. 40 Nm

**OE Manufacturer/Part No.**

Manufacturer	Original Part No.	Model
Scania	1726241	ADA1300