

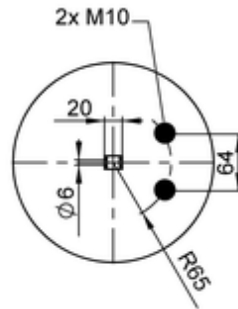

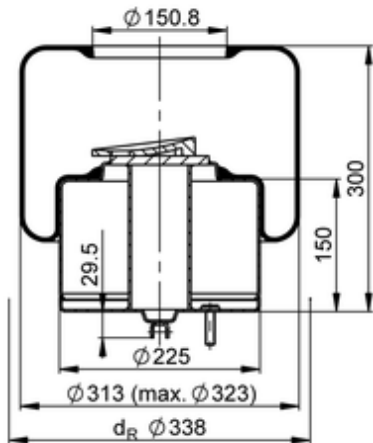







6610 N P01

69592



-  bolt or stud
-  hole
-  combination stud
-  air inlet
-  stud and nut

Article status	Normal
GTIN/EAN	4054391107462
Bellow number	6610 N
 kg	7,7 kg
	10086840
	K006
	
	M10: max. 40 Nm

### OE Manufacturer/Part No.

Manufacturer	Original Part No.	Model
Volvo	20 573 305	
Volvo	20 573 306	B11R

Volvo

20 573 306

B13R