

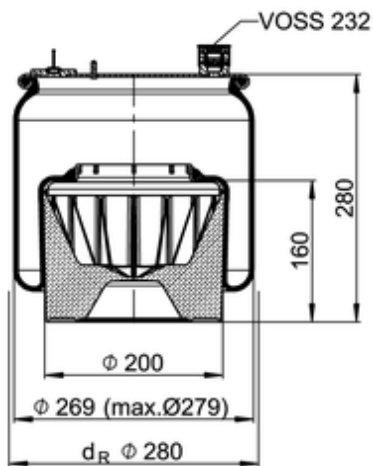







6173 N P41

600317



-  bolt or stud
-  hole
-  combination stud
-  air inlet
-  stud and nut

Article status	Normal
GTIN/EAN	4054391143392
Bellow number	6173 N
 kg	5 kg
	10087370
	

### OE Manufacturer/Part No.

Manufacturer	Original Part No.	Model
Mercedes	961 320 55 21	
Mercedes	961 320 47 21	
Mercedes	961 320 43 21	
Mercedes	A 961 320 55 21	Actros MP4
Mercedes	A 961 320 47 21	Actros MP4

Mercedes

A 961 320 43 21

Actros MP4