

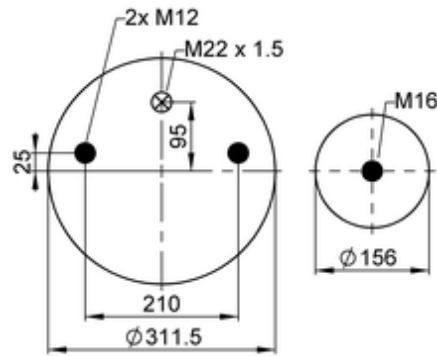

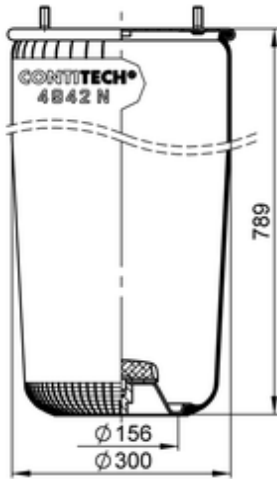



4942 N P02

67258



bolt or stud   
  hole   
  combination stud   
  air inlet   
 
●
 stud and nut

Article status	Normal
GTIN/EAN	4054391104089
Bellow number	4942 N
 kg	8 kg
	10086758
	K029
	M12: max. 70 Nm
	M16: max. 130 Nm
	M22x1.5: max. 20 Nm

OE Manufacturer/Part No.

Manufacturer	Original Part No.	Model
--------------	-------------------	-------

