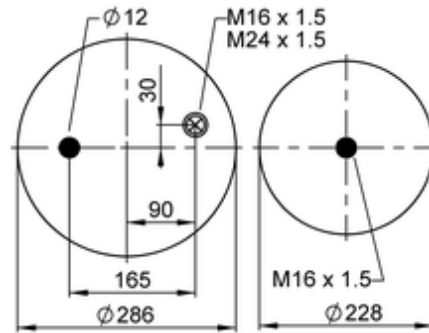
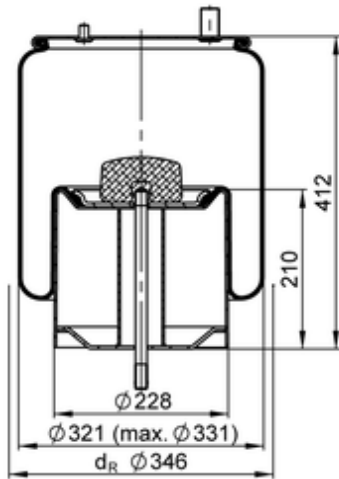

4912 N P13
67834

- bolt or stud
- hole
- combination stud
- air inlet
- stud and nut

| | |
|----------------|----------------------|
| Article status | Normal |
| GTIN/EAN | 4054391106113 |
| Bellow number | 4912 N |
| kg | 13,7 kg |
| | 10086799 |
| | K018 |
| | |
| | M16x1.5: max. 180 Nm |
| | M16x1.5: max. 80 Nm |
| | M24x1.5: max. 120 Nm |

OE Manufacturer/Part No.

| Manufacturer | Original Part No. | Model |
|---------------------|--------------------------|---------------------------|
| Renault | 7.421.978.494 | Premium / Magnum standard |
| Renault | 5.010.600.328 | Premium / Magnum standard |
| Volvo | 20 726 768 | FM / FH Standard |
| Volvo | 21 978 504 | FM / FH Standard |