

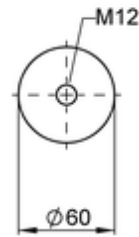

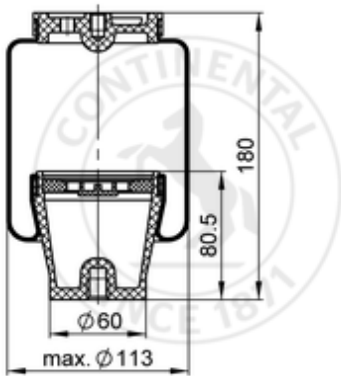







SZ 55-20 P01

62772



-  bolt or stud
-  hole
-  combination stud
-  air inlet
-  stud and nut

 kg	0,5 kg
	9305616
	G1/8: max. 12 Nm
	M10: max. 12 Nm
	M12: max. 15 Nm

OE Manufacturer/Part No.

Manufacturer	Original Part No.	Model
Linnepe		