

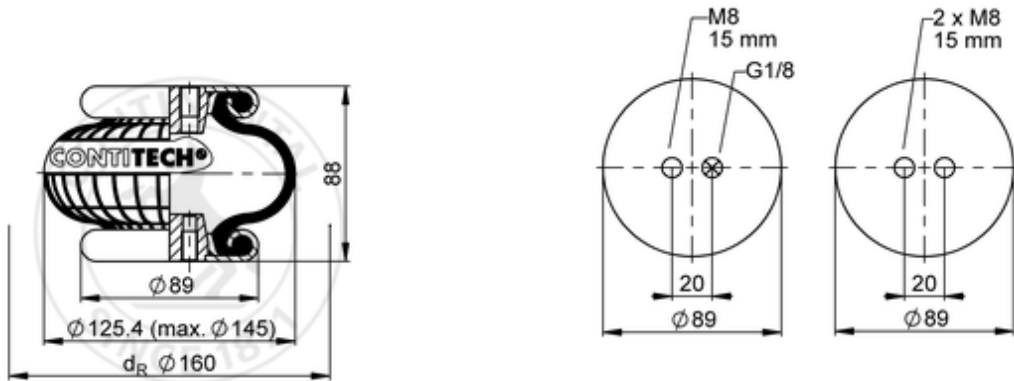







FS 40-6 1/8 M8

2681001000



-  bolt or stud
-  hole
-  combination stud
-  air inlet
-  stud and nut

 kg	0,9 kg
	G1/8: max. 25 Nm
	M8: max. 25 Nm

OE Manufacturer/Part No.

Manufacturer	Original Part No.	Model
Volvo	AH-0188	