

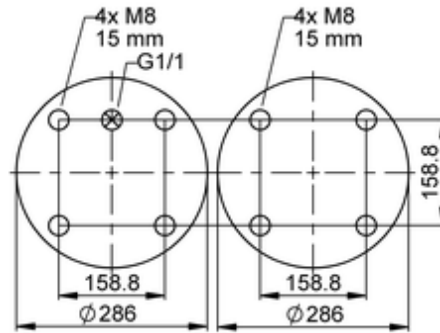

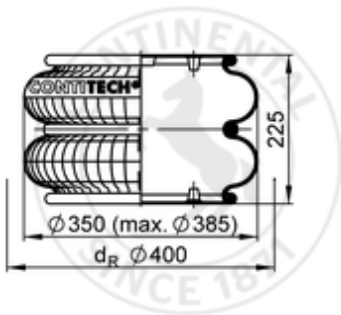





FD 530-22 1/1 M8

2682075000



-  bolt or stud
-  hole
-  combination stud
-  air inlet
-  stud and nut

| | |
|--|------------------|
|  kg | 6,9 kg |
|  | G1/1: max. 50 Nm |
|  | M8: max. 25 Nm |

OE Manufacturer/Part No.

| Manufacturer | Original Part No. | Model |
|--------------|-------------------|-------|
| DAF | 1 307 058 | |