

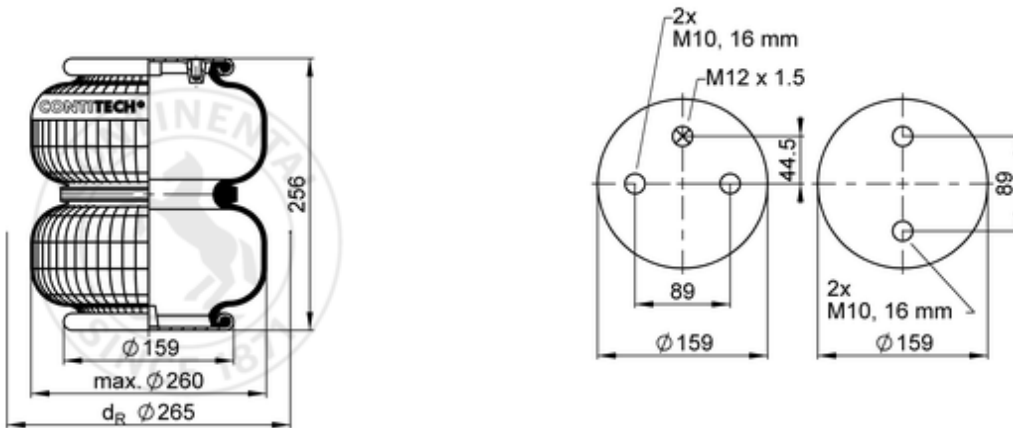







FD 200-25 P02

66476



-  bolt or stud
-  hole
-  combination stud
-  air inlet
-  stud and nut

 kg	3,2 kg
	M10: max. 35 Nm
	M12x1.5: max. 40 Nm

OE Manufacturer/Part No.

Manufacturer	Original Part No.	Model
SAF - Holland	1608	
SAF - Holland	4.229.1005.00	1608
SAF - Holland	4.229.1005.01	1608