

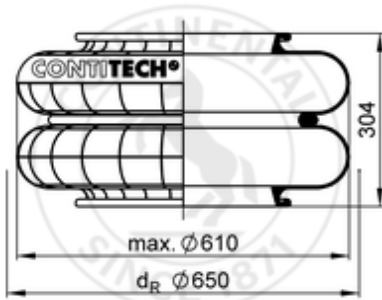







FD 1730-40

72730



-  bolt or stud
-  hole
-  combination stud
-  air inlet
-  stud and nut

	9,2 kg
	700 N
	10002970

**OE Manufacturer/Part No.**

Manufacturer	Original Part No.	Model
Kässbohrer	4.731.022.000	
Jost	212014000	
Jost	212013000	
Jost	1013956	