

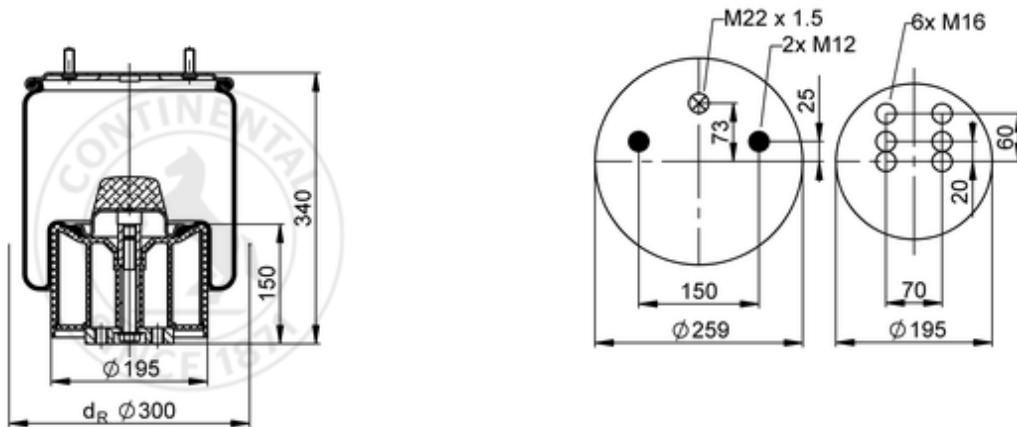











940 MB P30

73420



 bolt or stud
  hole
  combination stud
  air inlet
  stud and nut

 kg	8,8 kg
	10003039
	K029
	
	M12: max. 70 Nm
	M16: max. 230 Nm
	M22x1.5: max. 20 Nm

OE Manufacturer/Part No.

Manufacturer	Original Part No.	Model
BPW	05.429.43.21.0	30 K
Scania	2198483	30 K
Schmitz	017 331	30 K
Schmitz	751 084	30 K

