

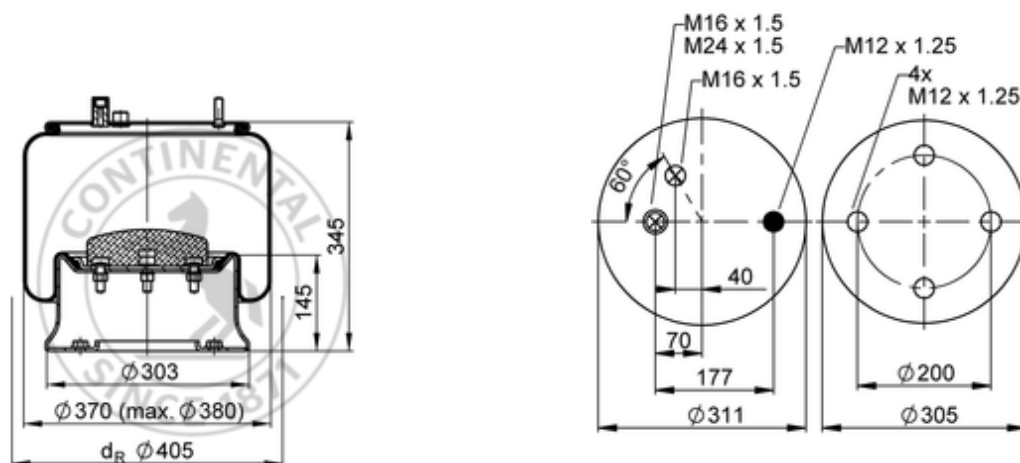









902 MB

2686080000



-  bolt or stud
-  hole
-  combination stud
-  air inlet
-  stud and nut

16,7 kg

 M12x1.25: max. 70 Nm
 M16x1.5: max. 80 Nm
 M24x1.5: max. 120 Nm

OE Manufacturer/Reference No.

Manufacturer	Original-part no.	Model
Renault	5.010.211.724	Premium. Magnum R380
Renault	5.000.815.749	Magnum