

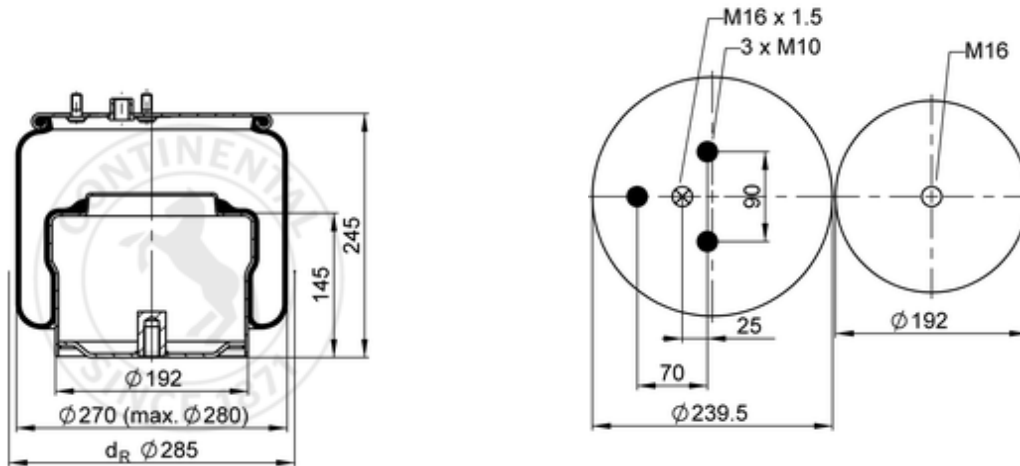











889 M K2

67200



 bolt or stud
  hole
  combination stud
  air inlet
  stud and nut

 kg	7,2 kg
	K008
	
	M10: max. 35 Nm
	M16: max. 130 Nm
	M16x1.5: max. 40 Nm

OE Manufacturer/Part No.

Manufacturer	Original Part No.	Model
DAF	1 529 835	
DAF	1 279 141	
DAF	1 698 434	CF 65
DAF	1 698 434	CF 75-85
DAF	1 698 434	LF 45-55

DAF

1 698 434

XF 95-105