

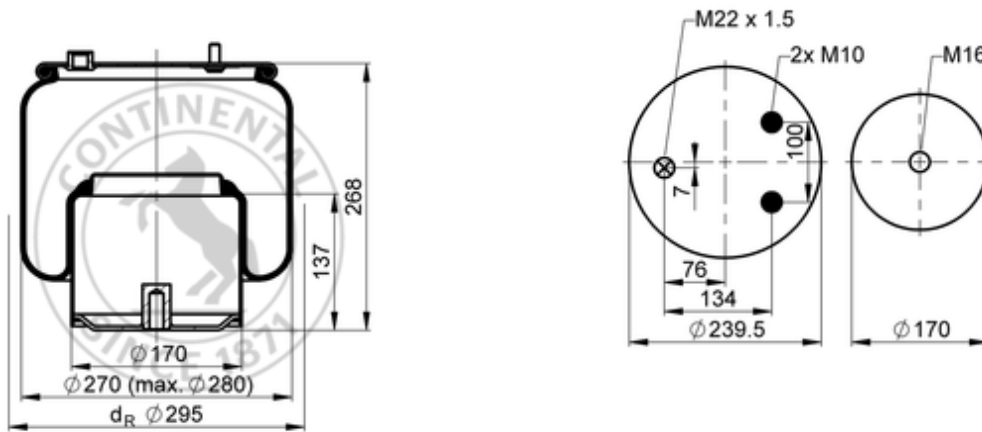









887 N P08

78201



-  bolt or stud
-  hole
-  combination stud
-  air inlet
-  stud and nut

 kg	5,6 kg
	
	M10: max. 45 Nm
	M16: max. 170 Nm
	M22x1.5: max. 20 Nm

OE Manufacturer/Part No.

Manufacturer	Original Part No.	Model
DAF	1 794 427	FAR, FAS