

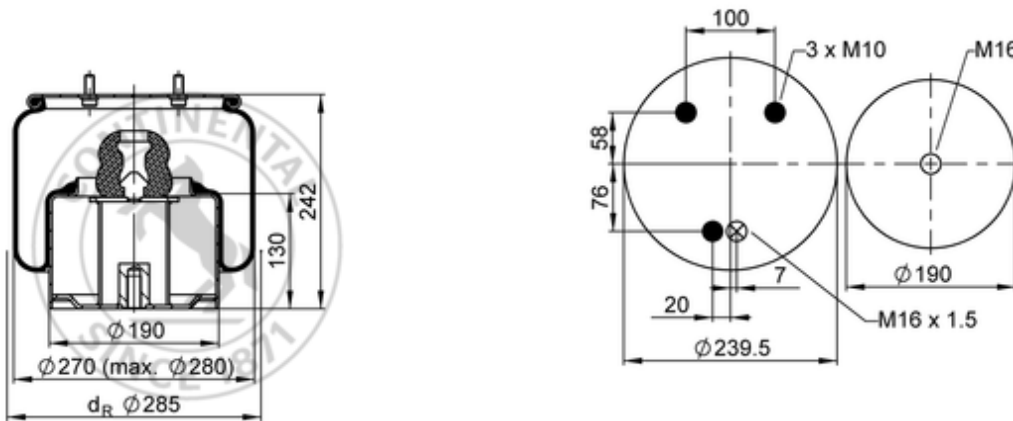











887 N P04

63276



 bolt or stud  
  hole  
  combination stud  
  air inlet  
  stud and nut

 kg	8 kg
	887 MB K6
	K008
	
	M10: max. 35 Nm
	M16: max. 130 Nm
	M16x1.5: max. 40 Nm

### OE Manufacturer/Part No.

Manufacturer	Original Part No.	Model
VDL Bus	1 154 761	
VDL Bus	1 141 525	
VDL Bus	41 141 525	
VDL Bus	41 154 761	

