

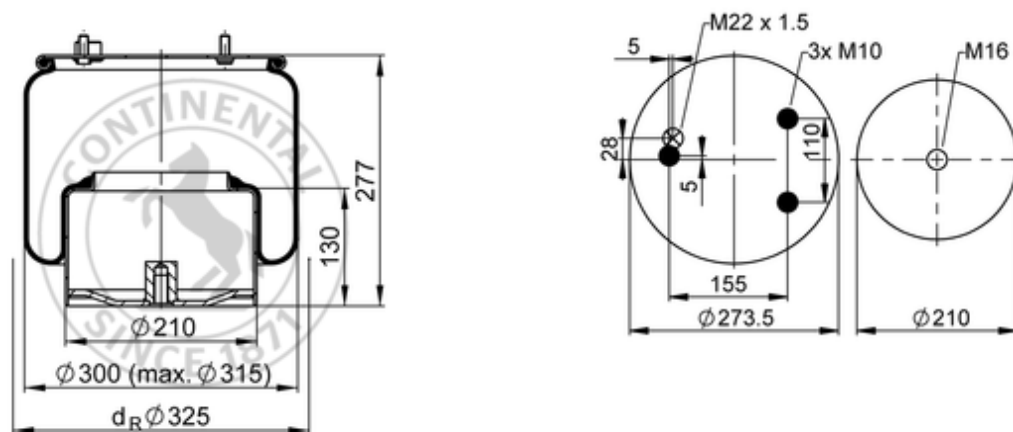









836 N P16

70541



 bolt or stud
  hole
  combination stud
  air inlet
  stud and nut

	8,4 kg
	K008
	
	M10: max. 35 Nm
	M16: max. 130 Nm
	M22x1.5: max. 20 Nm

OE Manufacturer/Reference No.

Manufacturer	Original-part no.	Model
VDL Bus	30023245	
VDL Bus	45015338	
VDL Bus	5015338	