

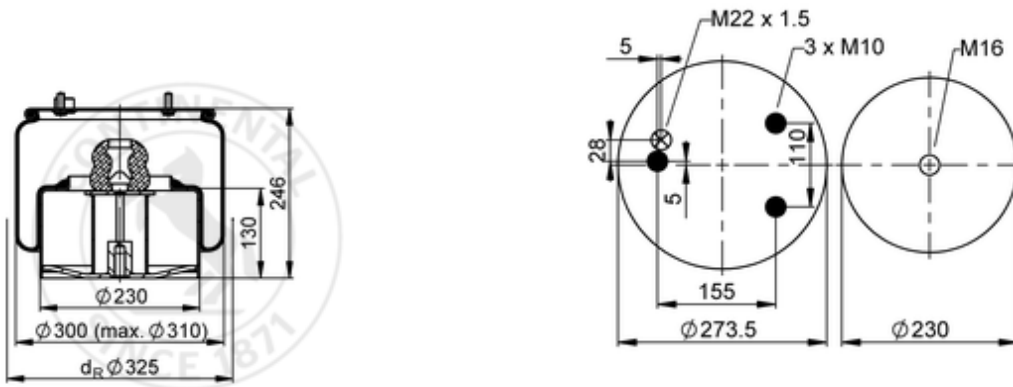











836 N P05

63274



 bolt or stud
  hole
  combination stud
  air inlet
  stud and nut

 kg	10,3 kg
	K008
	
	M10: max. 35 Nm
	M16: max. 130 Nm
	M22x1.5: max. 20 Nm

OE Manufacturer/Part No.

Manufacturer	Original Part No.	Model
VDL Bus	41 153 933	
VDL Bus	1 153 933	SB230
VDL Bus	1 153 933	SB235
VDL Bus	1 153 933	SB260
VDL Bus	1 153 933	SB300

VDL Bus

1 153 933

SB400