

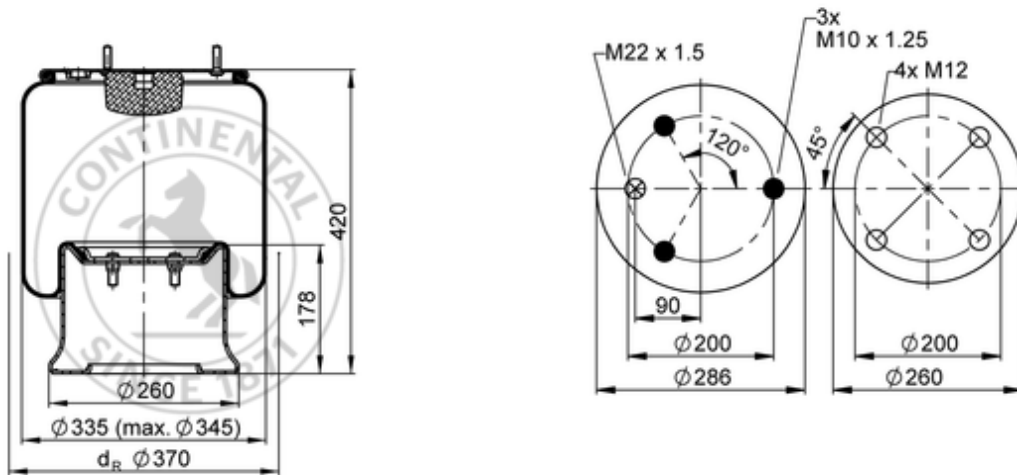









811 MB

67189



 bolt or stud
  hole
  combination stud
  air inlet
  stud and nut

 kg	11,7 kg
	
	M10x1.25: max. 35 Nm
	M12: max. 70 Nm
	M22x1.5: max. 20 Nm

OE Manufacturer/Part No.

Manufacturer	Original Part No.	Model
Renault	5.000.745.918	
DAF	1 384 274	FA 3000