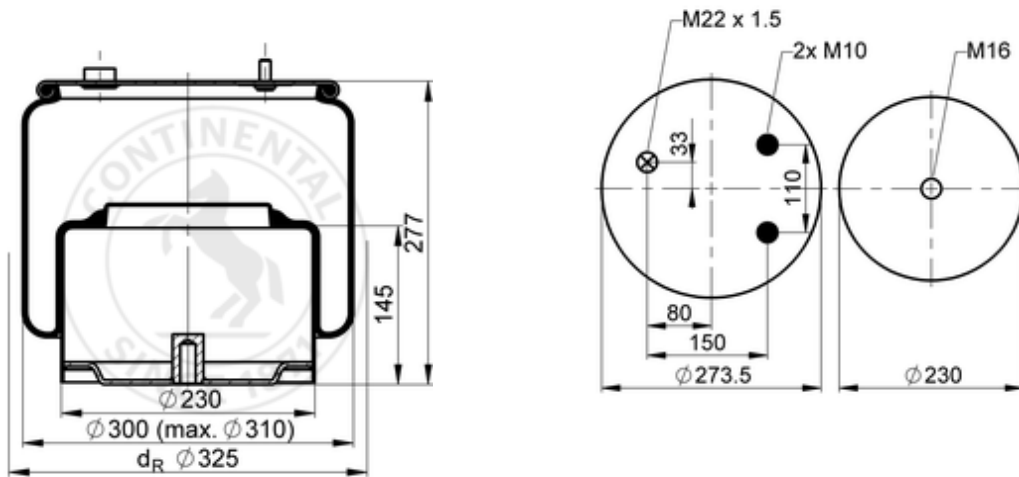

6755 N P01
78206

- bolt or stud
- hole
- combination stud
- air inlet
- stud and nut

kg	8,1 kg
	M10: max. 45 Nm
	M16: max. 170 Nm
	M22x1.5: max. 20 Nm

OE Manufacturer/Part No.

Manufacturer	Original Part No.	Model
DAF	1 901 305	FAR