

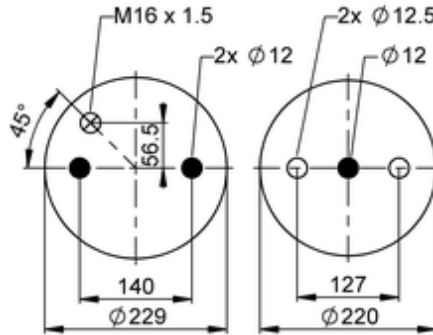

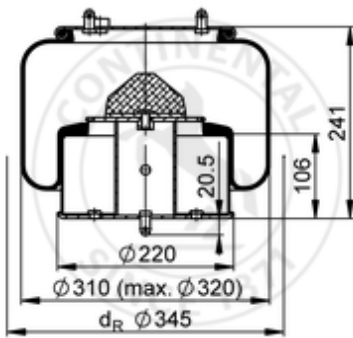







6712 N P02

53877



-  bolt or stud
-  hole
-  combination stud
-  air inlet
-  stud and nut

	7,5 kg
	K031
	
	M16x1.5: max. 40 Nm

OE Manufacturer/Part No.

Manufacturer	Original Part No.	Model
Scania	1726247	ASA701, ARA860
Scania	1726247	tandem load 19 ton