

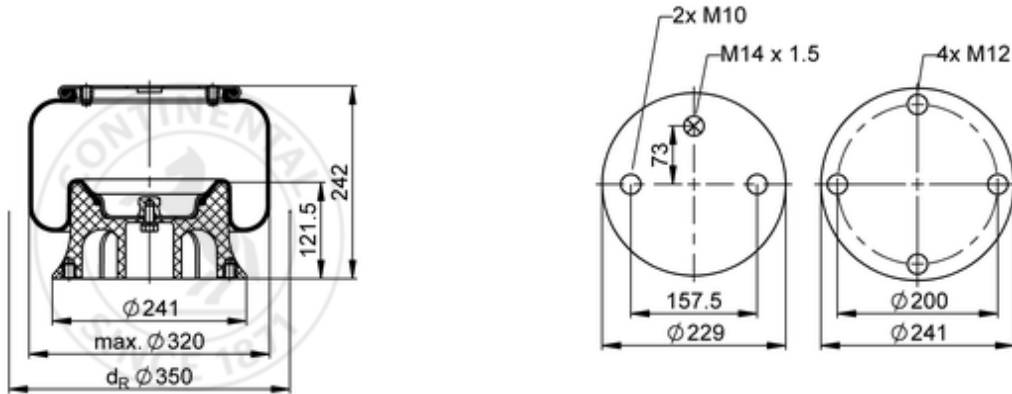









6707 N P01

53862



-  bolt or stud
-  hole
-  combination stud
-  air inlet
-  stud and nut

 kg	5,7 kg
	
	M10: max. 40 Nm
	M12: max. 70 Nm
	M14x1.5: max. 20 Nm

**OE Manufacturer/Part No.**

Manufacturer	Original Part No.	Model
Scania	1865756	4-Series LOW