

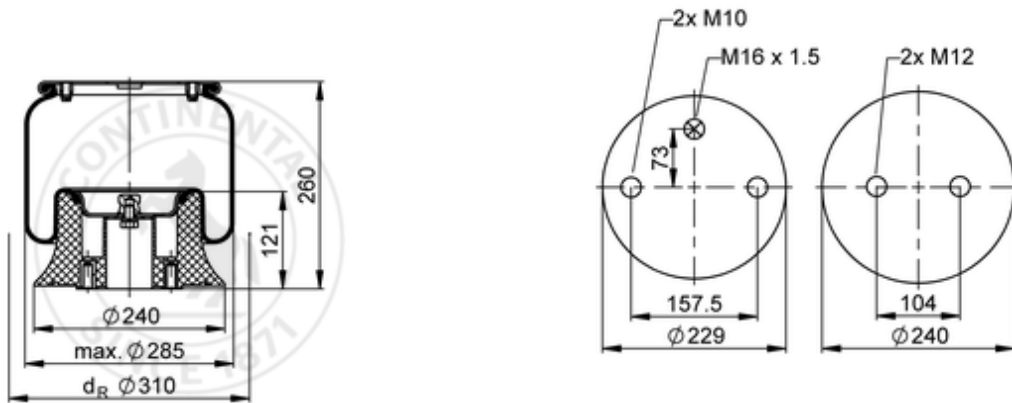









6705 N P01

53860



 bolt or stud
  hole
  combination stud
  air inlet
  stud and nut

 kg	5,4 kg
	
	M10: max. 40 Nm
	M12: max. 60 Nm
	M16x1.5: max. 20 Nm

OE Manufacturer/Part No.

Manufacturer	Original Part No.	Model
Scania	1402423	
Scania	1394997	
Scania	1314903	
Scania	1865759	Scania P,R,T
Scania	2517987	Scania P,R,T

