

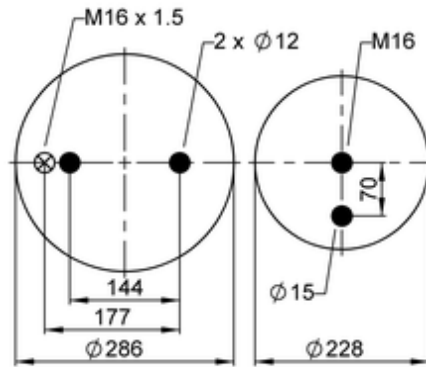

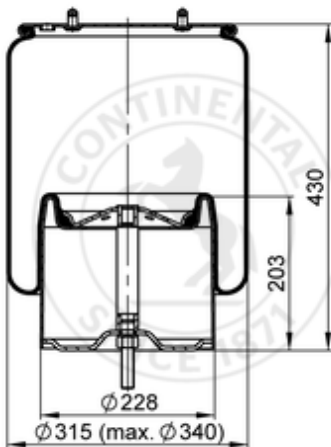



6700 N P01

69210



bolt or stud   
  hole   
  combination stud   
  air inlet   
  stud and nut

 kg	12,5 kg
	1113 N P01
	K004
	
	M16: max. 130 Nm
	M16x1.5: max. 20 Nm

**OE Manufacturer/Part No.**

Manufacturer	Original Part No.	Model
Scania	2287814	
Scania	1510195	R-Series
Scania	1543691	R-Series new generation
Scania	1731113	R-Series low, extra low

