

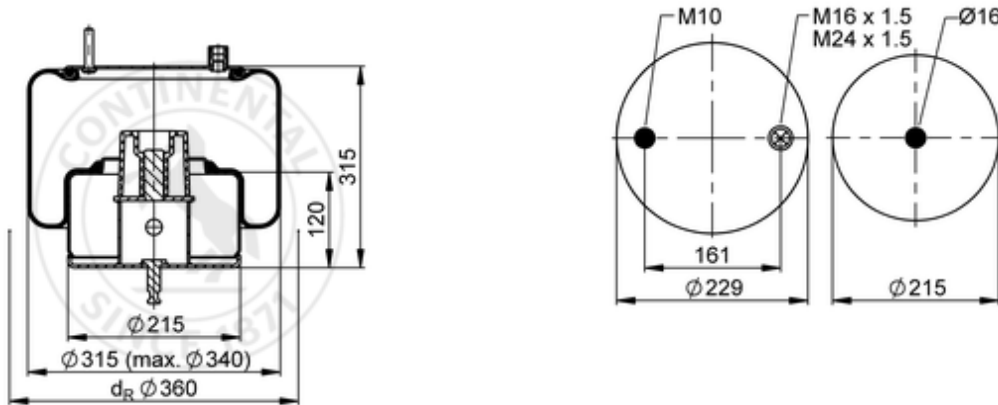









6634 N P01

53871



-  bolt or stud
-  hole
-  combination stud
-  air inlet
-  stud and nut

 kg	8,1 kg
	
	M10: max. 40 Nm
	M16x1.5: max. 20 Nm
	M24x1.5: max. 60 Nm

**OE Manufacturer/Part No.**

Manufacturer	Original Part No.	Model
Volvo	21 325 230	FH medium / low