

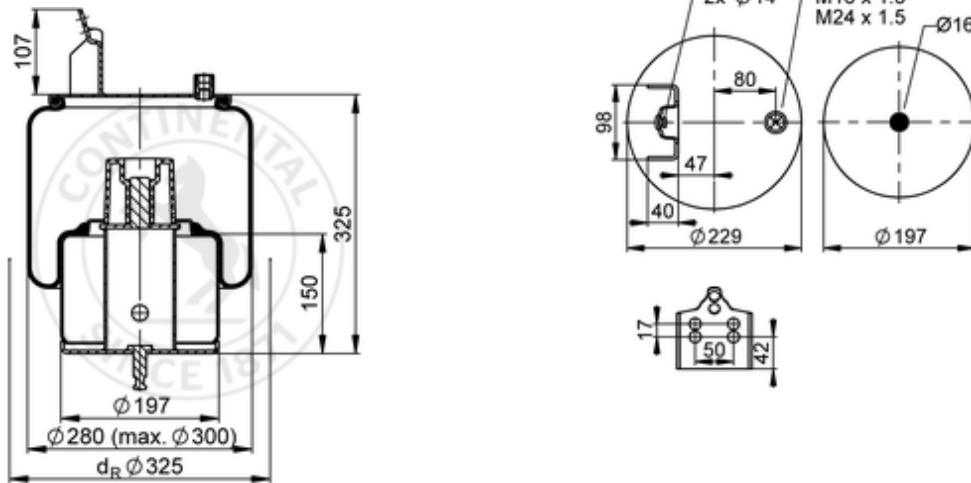









6630 N P01

53864



-  bolt or stud
-  hole
-  combination stud
-  air inlet
-  stud and nut

 kg	8,2 kg
	
	M16x1.5: max. 20 Nm
	M24x1.5: max. 60 Nm

**OE Manufacturer/Part No.**

Manufacturer	Original Part No.	Model
Volvo	21 977 973	FH standard
Volvo	20 909 150	FH standard