

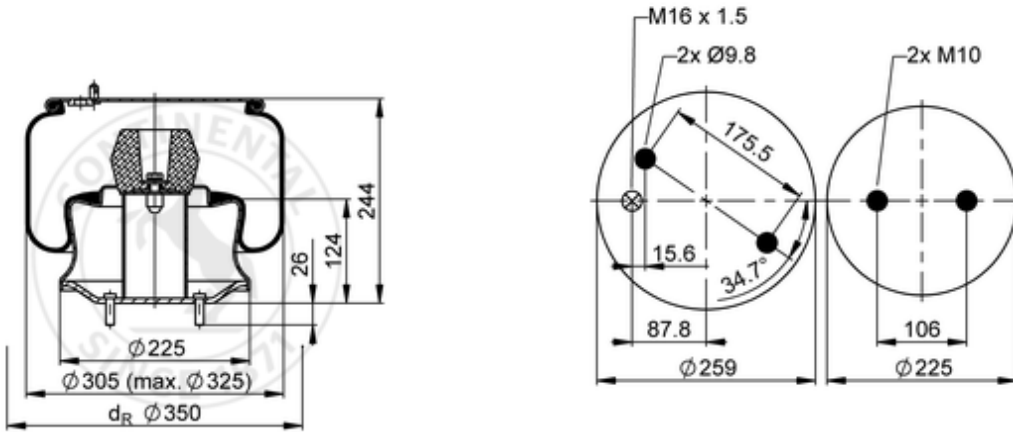









6620 N P02

53844



-  bolt or stud
-  hole
-  combination stud
-  air inlet
-  stud and nut

 kg	9,3 kg
	
	M10: max. 30 Nm
	M16x1.5: max. 40 Nm

**OE Manufacturer/Part No.**

Manufacturer	Original Part No.	Model
Volvo	21 097 433	
Volvo	21 057 936	
Volvo	70 311 683	
Volvo	21 513 833	B7RLE/ B9LE/ B9RLE/ B9S/ B9TL