

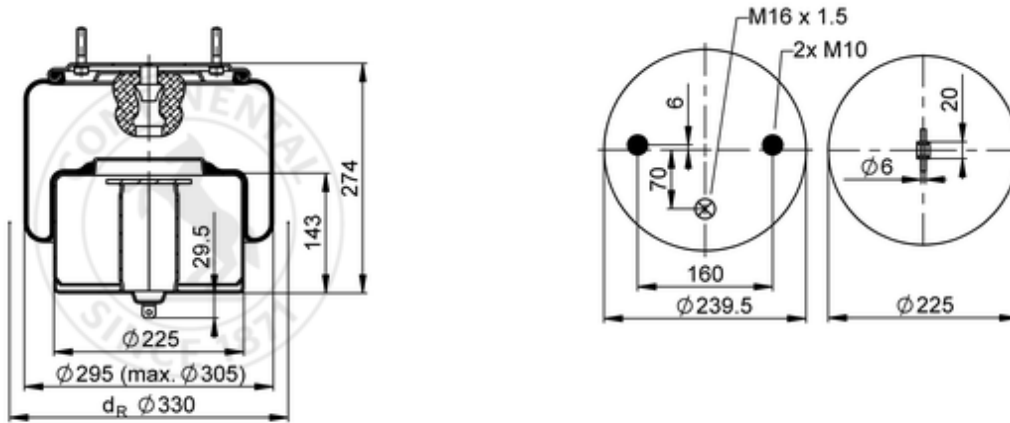









6617 N P01

78041



-  bolt or stud
-  hole
-  combination stud
-  air inlet
-  stud and nut

 kg	8,3 kg
	
	M10: max. 40 Nm
	M16x1.5: max. 20 Nm

OE Manufacturer/Part No.

Manufacturer	Original Part No.	Model
Volvo	21 161 555	
Volvo	21 961 478	FM / FH medium
Volvo	21 119 077	FM / FH medium