

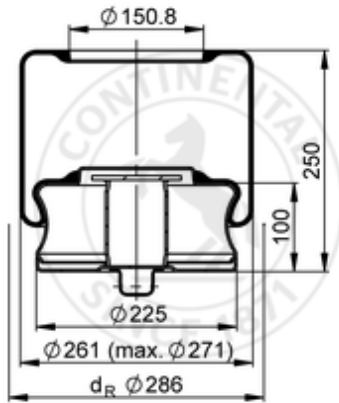







6611 N P02

72814



-  bolt or stud
-  hole
-  combination stud
-  air inlet
-  stud and nut

	5,9 kg
	

**OE Manufacturer/Part No.**

Manufacturer	Original Part No.	Model
Volvo	70 397 048	B7R
Volvo	70 397 048	B11R
Volvo	70 397 048	B13R
Volvo	70 397 048	B9R