

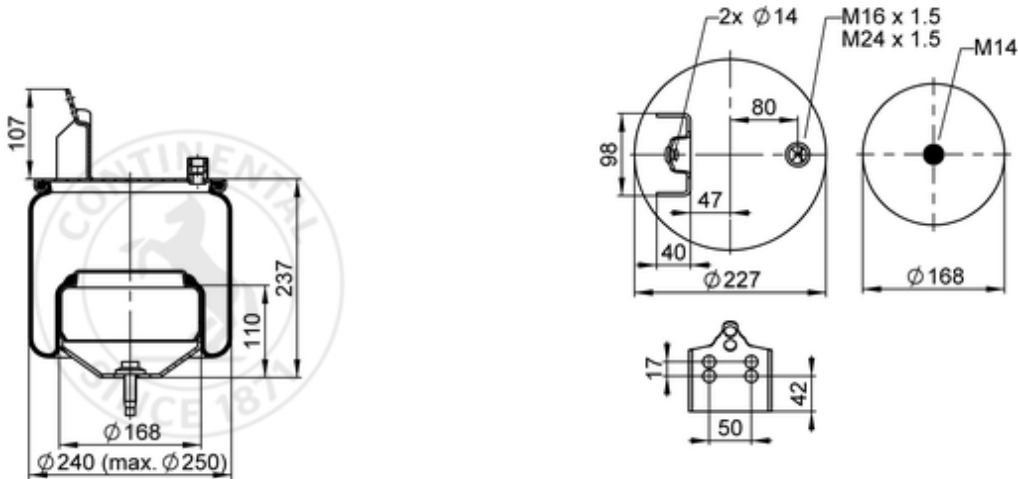









6600 N P02

69666



 bolt or stud
  hole
  combination stud
  air inlet
  stud and nut

 kg	4,9 kg
	K005
	
	M14: max. 120 Nm
	M24x1.5: max. 60 Nm

OE Manufacturer/Part No.

Manufacturer	Original Part No.	Model
Volvo	1 076 420	
Volvo	20 531 989	
Volvo	20 456 160	
Volvo	20 374 512	
Volvo	20 582 213	FM / FH low
Volvo	21 961 448	FM / FH low

