

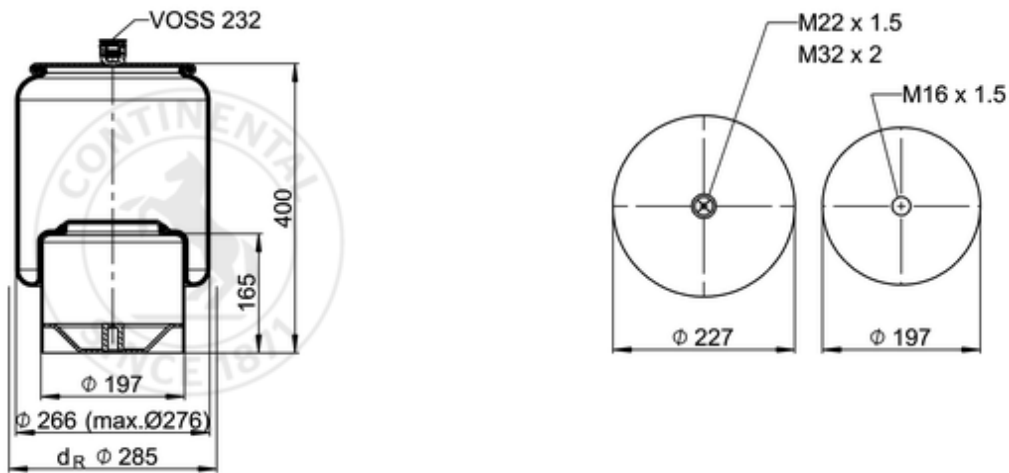







6123 N P40

74986



-  bolt or stud
-  hole
-  combination stud
-  air inlet
-  stud and nut

	7,6 kg
	M16x1.5: max. 130 Nm

OE Manufacturer/Part No.

Manufacturer	Original Part No.	Model
Mercedes	960 320 06 57	
Mercedes	960 320 71 57	
Mercedes	A 960 320 06 57	Actros MP4
Mercedes	A 960 320 71 57	Actros MP4