

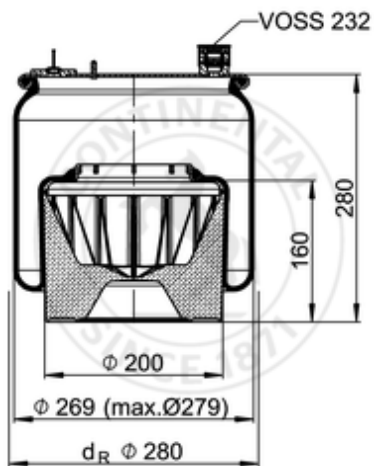







6122 N P47

74985



-  bolt or stud
-  hole
-  combination stud
-  air inlet
-  stud and nut

	5 kg
	
	M16x1.5: max. 20 Nm

OE Manufacturer/Part No.

Manufacturer	Original Part No.	Model
Mercedes	960 320 50 57	
Mercedes	960 320 01 57	
Mercedes	960 320 68 57	
Mercedes	960 320 77 21	
Mercedes	A 960 320 68 57	Actros MP4
Mercedes	A 960 320 77 21	Actros MP4
Mercedes	A 960 320 01 57	Actros MP4
Mercedes	A 960 320 50 57	Actros MP4

