

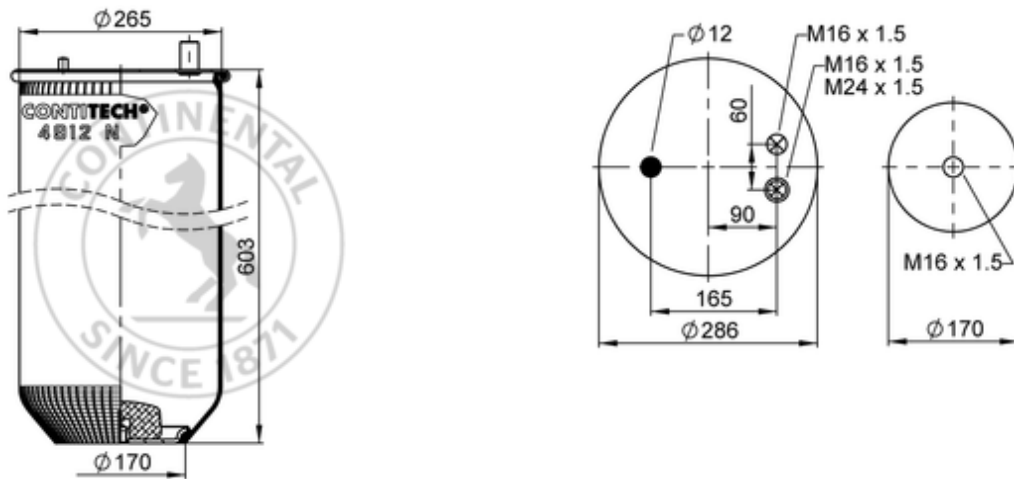









4912 N P08

67253



 bolt or stud
  hole
  combination stud
  air inlet
  stud and nut

 kg	6,8 kg
	K018
	M16x1.5: max. 180 Nm
	M16x1.5: max. 80 Nm
	M24x1.5: max. 120 Nm

OE Manufacturer/Part No.

Manufacturer	Original Part No.	Model
Renault	5.001.832.067	Magnum / Premium