

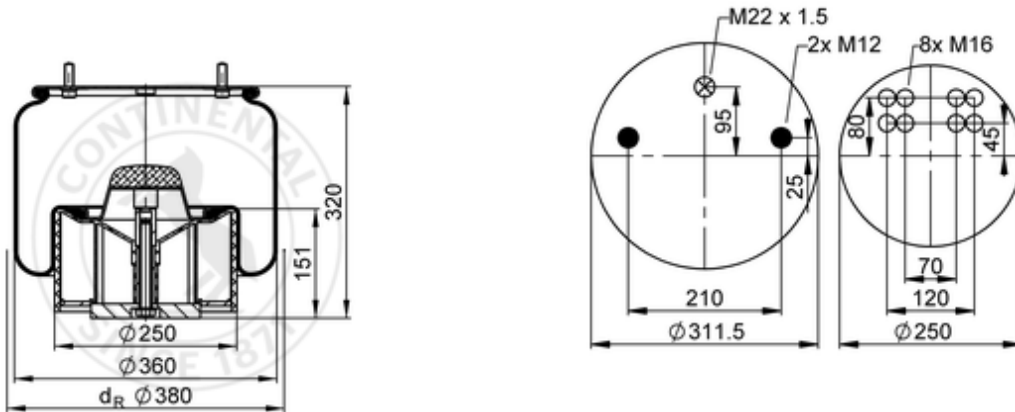











4881 N P30

73422



 bolt or stud
  hole
  combination stud
  air inlet
  stud and nut

	12,6 kg
	10003040
	K029
	
	M12: max. 70 Nm
	M16: max. 230 Nm
	M22x1.5: max. 20 Nm

OE Manufacturer/Part No.

Manufacturer	Original Part No.	Model
Scania	2198331	
BPW	05.429.43.41.0	36 K
Hüffermann	6-AB8003-0200	36 K
Schmitz	750 491	36 K

