

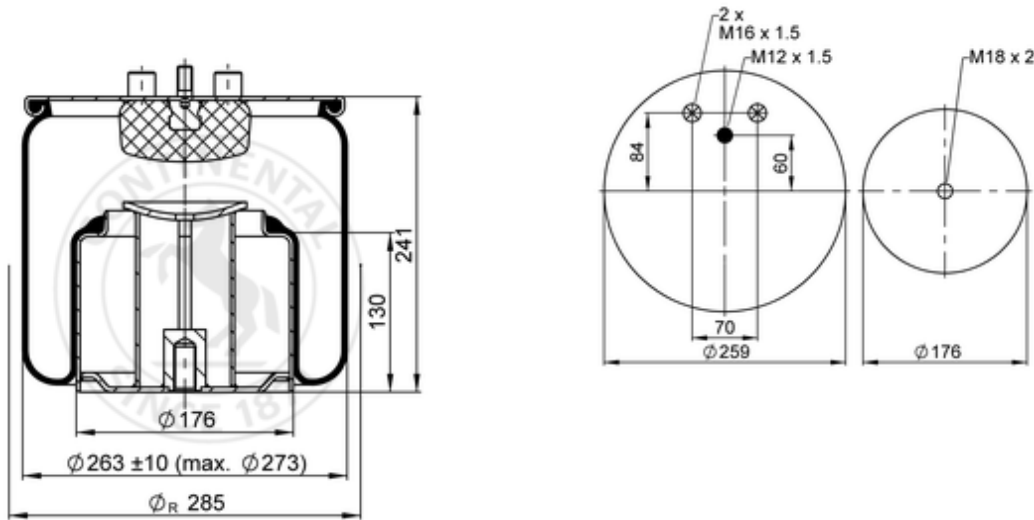











4878 N1 P01

78121



-  bolt or stud
-  hole
-  combination stud
-  air inlet
-  stud and nut

 kg	8,5 kg
	K033
	
	M12x1.5: max. 40 Nm
	M16x1.5: max. 40 Nm
	M18x2: max. 270 Nm

OE Manufacturer/Part No.

Manufacturer	Original Part No.	Model
MAN	81.43600.6048	low frame