

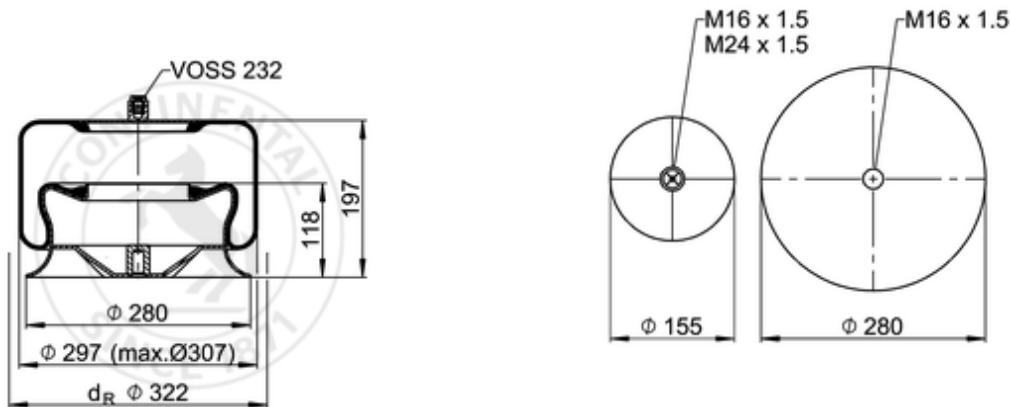











4759 N P21

600190



-  bolt or stud
-  hole
-  combination stud
-  air inlet
-  stud and nut

	6,6 kg
	65690
	K021
	
	M16x1.5: max. 130 Nm
	M24x1.5: max. 100 Nm

OE Manufacturer/Part No.

Manufacturer	Original Part No.	Model
Mercedes	942 320 02 17	
Mercedes	942 320 44 21	
Mercedes	A 942 320 44 21	Actros Low Liner
Mercedes	A 942 320 02 17	Actros Low Liner
Mercedes	A 942 320 02 17	Actros Low Liner

Mercedes

A 942 320 44 21

Actros Low Liner

© 2024 ContiTech Deutschland GmbH, ALL RIGHTS RESERVED. <https://www.continental-industry.com/>