

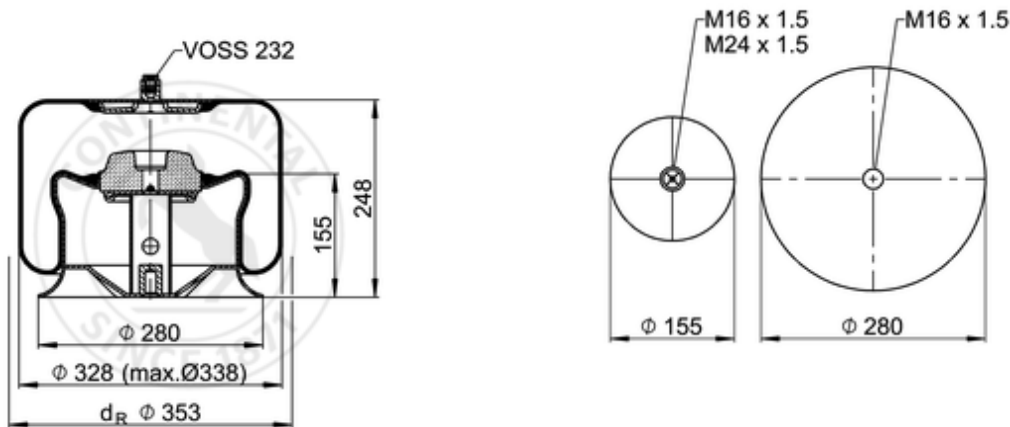











4737 N P25

600173



-  bolt or stud
-  hole
-  combination stud
-  air inlet
-  stud and nut

	9,5 kg
	63494
	K021
	
	M16x1.5: max. 130 Nm
	M24x1.5: max. 100 Nm

OE Manufacturer/Part No.

Manufacturer	Original Part No.	Model
Mercedes	957 320 01 17	
Mercedes	957 320 03 17	
Mercedes	A 957 320 01 17	Atego
Mercedes	A 957 320 01 17	Atego
Mercedes	A 957 320 03 17	Atego. Econic

Mercedes

A 957 320 03 17

Atego. Econic

© 2024 ContiTech Deutschland GmbH, ALL RIGHTS RESERVED. <https://www.continental-industry.com/>