

4705 N1 P03

76464

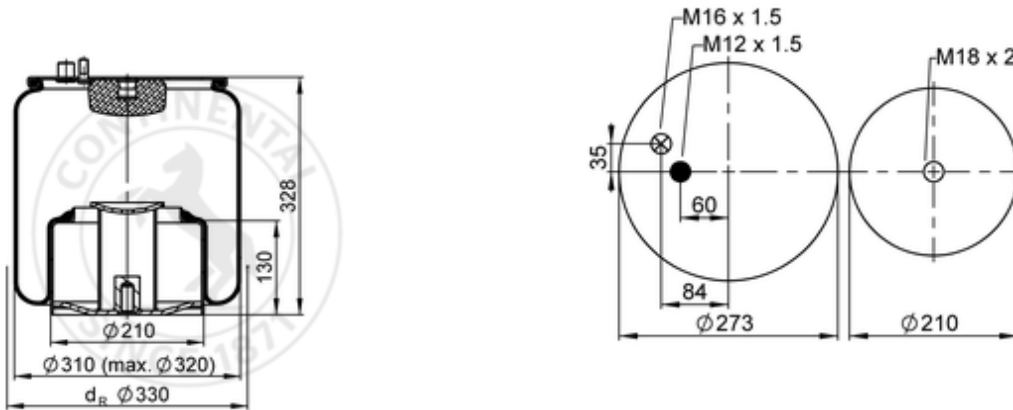







bolt or stud
 hole

+
 combination stud

x
 air inlet

+
 stud and nut

	10,9 kg
	65636
	K032
	
	M12x1.5: max. 40 Nm
	M16x1.5: max. 20 Nm
	M18x2: max. 180 Nm

OE Manufacturer/Part No.

Manufacturer	Original Part No.	Model
MAN	81.43600.6039	TGA ALV 11.5/7.1
MAN	81.43600.6039	TGA ALV 11.5/7.1

