

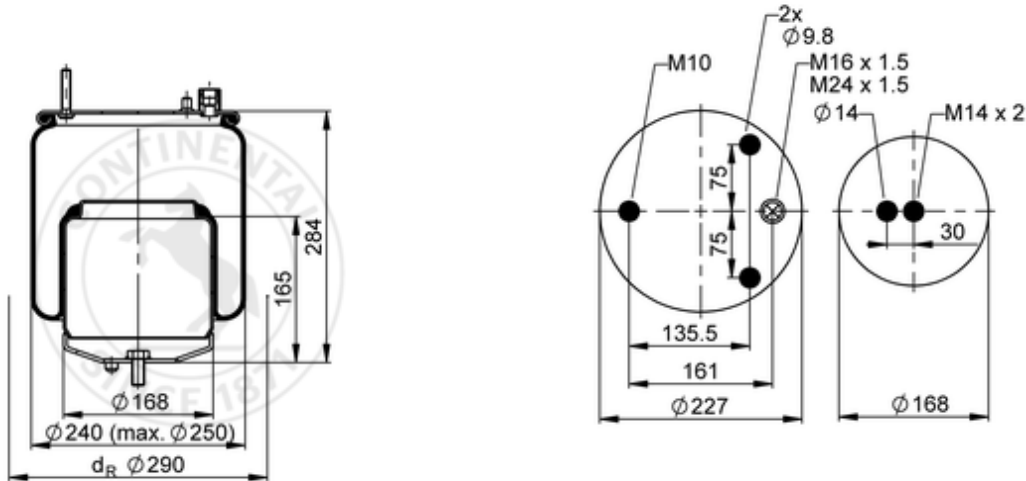











4571 N P02

78911



 bolt or stud
  hole
  combination stud
  air inlet
  stud and nut

 kg	5,8 kg
	75812
	
	M10: max. 40 Nm
	M14: max. 120 Nm
	M16x1.5: max. 20 Nm
	M24x1.5: max. 60 Nm

OE Manufacturer/Part No.

Manufacturer	Original Part No.	Model
Volvo	22 056 630	FM / FH medium
Volvo	21 224 750	FM / FH medium
Volvo	22 056 630	FM / FH medium
Volvo	21 224 750	FM / FH medium

