

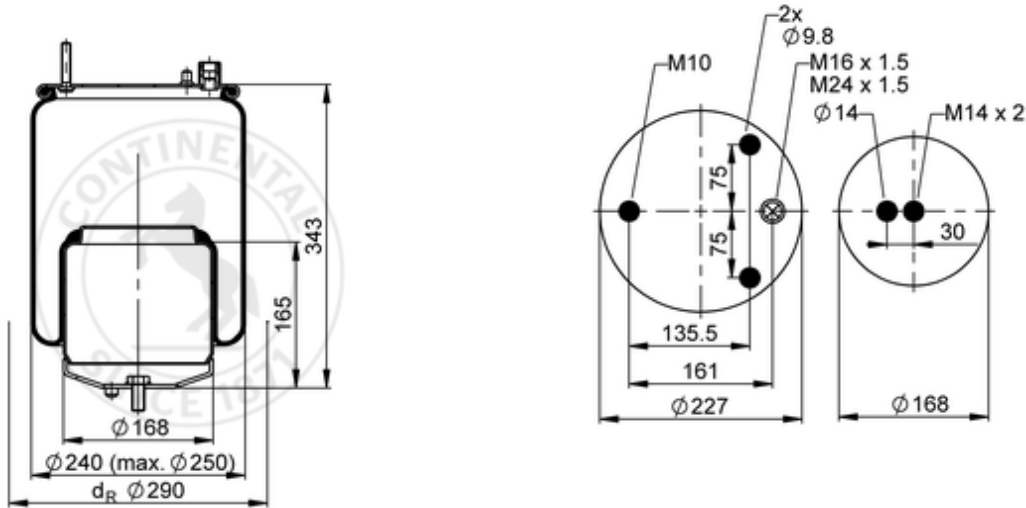











4570 N P02

75811



-  bolt or stud
-  hole
-  combination stud
-  air inlet
-  stud and nut

	6,2 kg
	
	M10: max. 40 Nm
	M14: max. 120 Nm
	M16x1.5: max. 20 Nm
	M24x1.5: max. 60 Nm

**OE Manufacturer/Part No.**

Manufacturer	Original Part No.	Model
Volvo	22 058 741	FM / FH std/high