

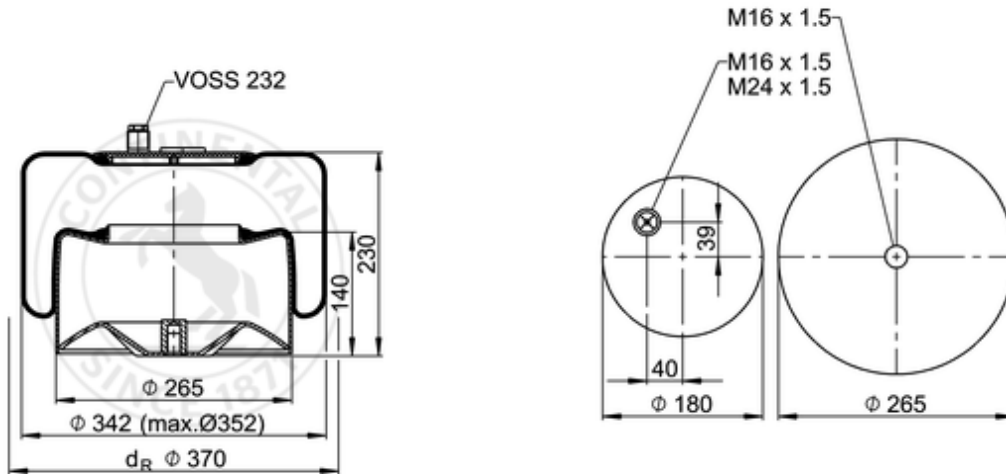











4186 N P23

600142



 bolt or stud
  hole
  combination stud
  air inlet
  stud and nut

 kg	8,7 kg
	69450
	K021
	
	M16x1.5: max. 130 Nm
	M24x1.5: max. 25 Nm

OE Manufacturer/Part No.

Manufacturer	Original Part No.	Model
Mercedes	942 320 16 21	
Mercedes	942 320 24 21	
Mercedes	942 320 70 21	
Mercedes	A 942 320 16 21	Actros
Mercedes	A 942 320 16 21	Actros

Mercedes	A 942 320 70 21	Actros MP2
Mercedes	A 942 320 24 21	Actros MP2
Mercedes	A 942 320 70 21	Actros MP2
Mercedes	A 942 320 24 21	Actros MP2