

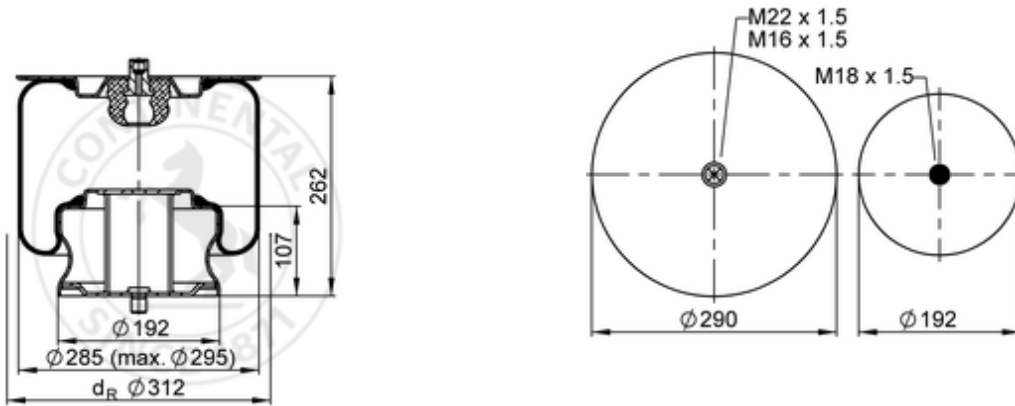











1782 N1 P01

62700



 bolt or stud
  hole
  combination stud
  air inlet
  stud and nut

 kg	7,7 kg
	K022
	
	M16x1.5: max. 20 Nm
	M18x1.5: max. 80 Nm
	M22x1.5: max. 40 Nm

OE Manufacturer/Part No.

Manufacturer	Original Part No.	Model
IRISBUS	5.010.531.180	Illiade/Ares